

# TECHNICAL DRAWING / DESSIN TECHNIQUE

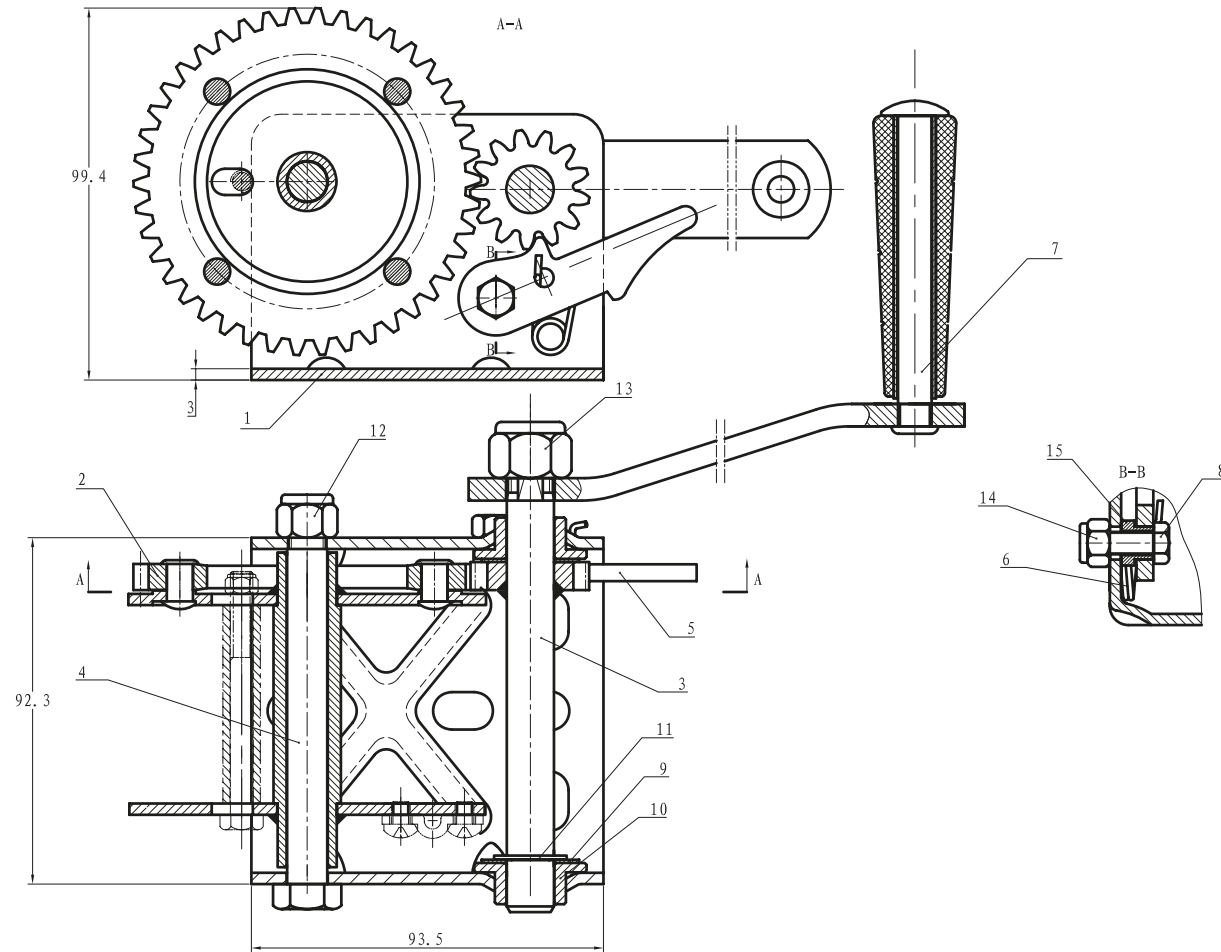

**JIMEXS**  
**HARDWARE**

1 866 447-5656 / INFO@JIMEXS.COM

WWW.JIMEXS-HARDWARE.COM

407-101

Treuil avec courroie et crochet  
 Winch with strap and hook

2022-01-26

PROJECTIONS

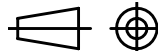

DIMENSIONS

1/4" x 36' - 3.2:1

MATERIAL / MATÉRIEL Acier plaqué zinc / Steel zinc plated

SPECS

600 lbs