

TECHNICAL DRAWING / DESSIN TECHNIQUE

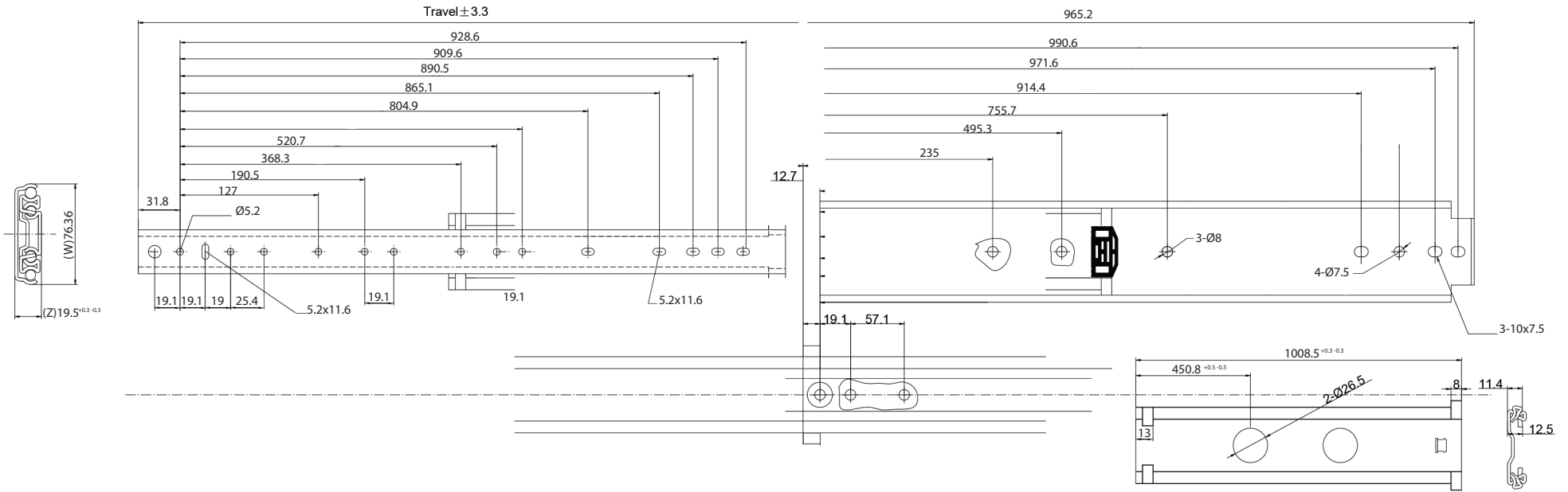

JIMEXS
HARDWARE

1 866 447-5656 / INFO@JIMEXS.COM

WWW.JIMEXS-HARDWARE.COM

323-540

Drawer Slides - 500 lbs series
 Glissières à tiroir - Serie 500 lbs

2021-07-05

PROJECTIONS

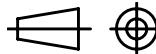

DIMENSIONS

MATERIAL/MATÉRIEL

SPECIFICATIONS/SPÉCIFICATIONS

40" x 3" x 3/4"

Steel zinc plated / Acier plaqué zinc

Can be use with M5 or M6 cross recessed
 pan head /

Peut être utilisée avec des vis M5 ou M6
 cruciforme à tête cylindrique large