

# TECHNICAL DRAWING / DESSIN TECHNIQUE

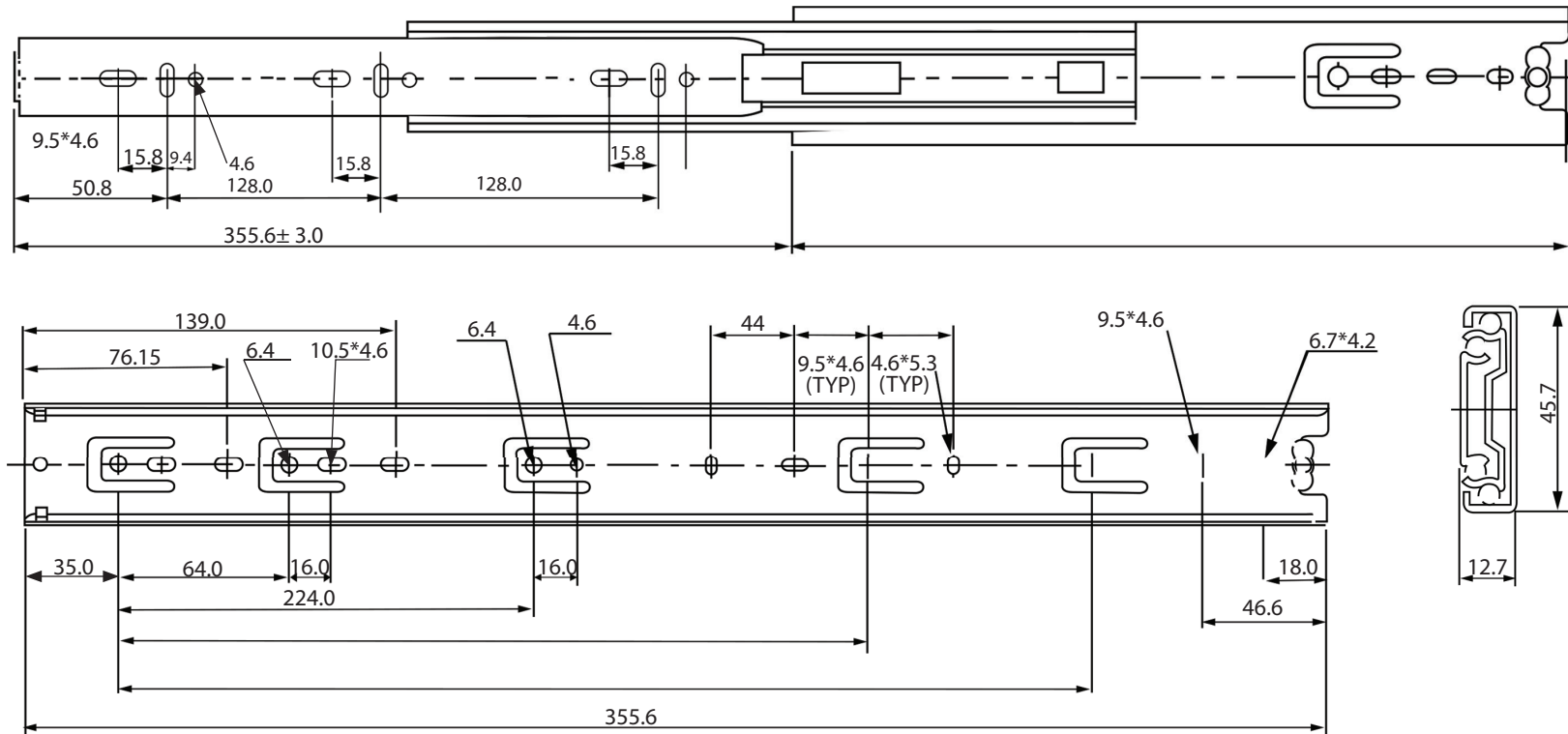

**JIMEXS**  
**HARDWARE**

1 866 447-5656 / INFO@JIMEXS.COM

WWW.JIMEXS-HARDWARE.COM

323-114

Drawer Slides - Cap. 100 lbs  
 Glissières pour tiroir - 100 lbs

2022-01-06

PROJECTIONS



DIMENSIONS

MATERIAL/MATÉRIEL

14" x 1.80" x 1/2"

Steel zinc plated /

Acier plaqué zinc