



Copie non contrôlée

Ce dessin ne doit pas être utilisé pour des fins de production

Uncontrolled copy

Do not use this drawing for manufacturing purposes

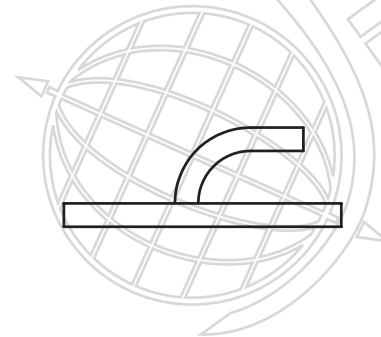
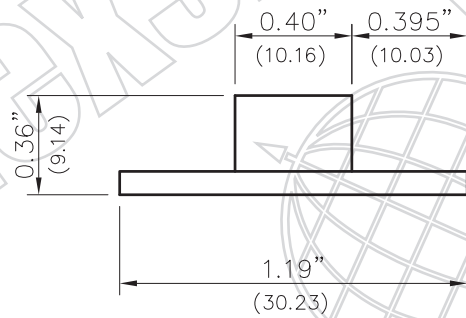
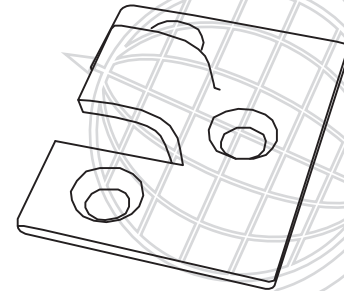
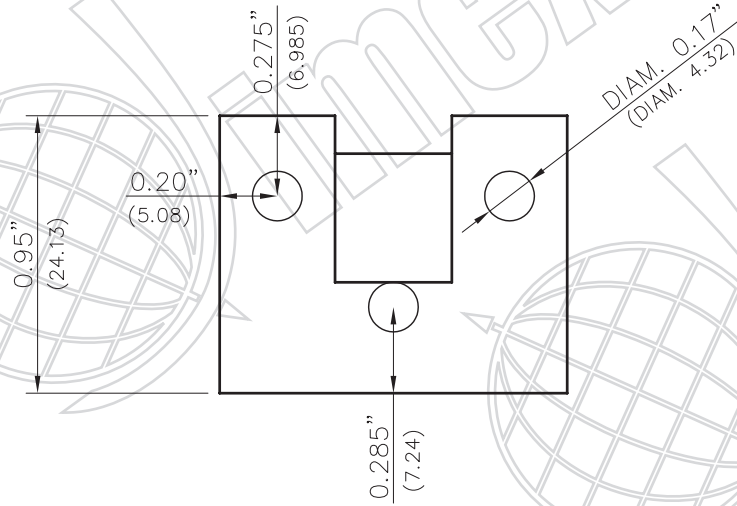

NUMERO DE PIÈCE/PART NUMBER		DESCRIPTION	
243-126		GÂCHE/STRIKER	
DESSIN PAR/DRAWING BY		MATÉRIEL/MATERIAL	FINI/FINISH
S.TARDIF		S/S	S/S
TEL: (450) 464-9999/1-866-447-5656		DATE	FEUILLE/SHEET
FAX: (450) 464-9992/1-866-447-5625		25/01/08	1/1
JIMEXS.COM / INFO@JIMEXS.COM		ÉCHELLE/SCALE	
		NAE	

