

# TECHNICAL DRAWING / DESSIN TECHNIQUE

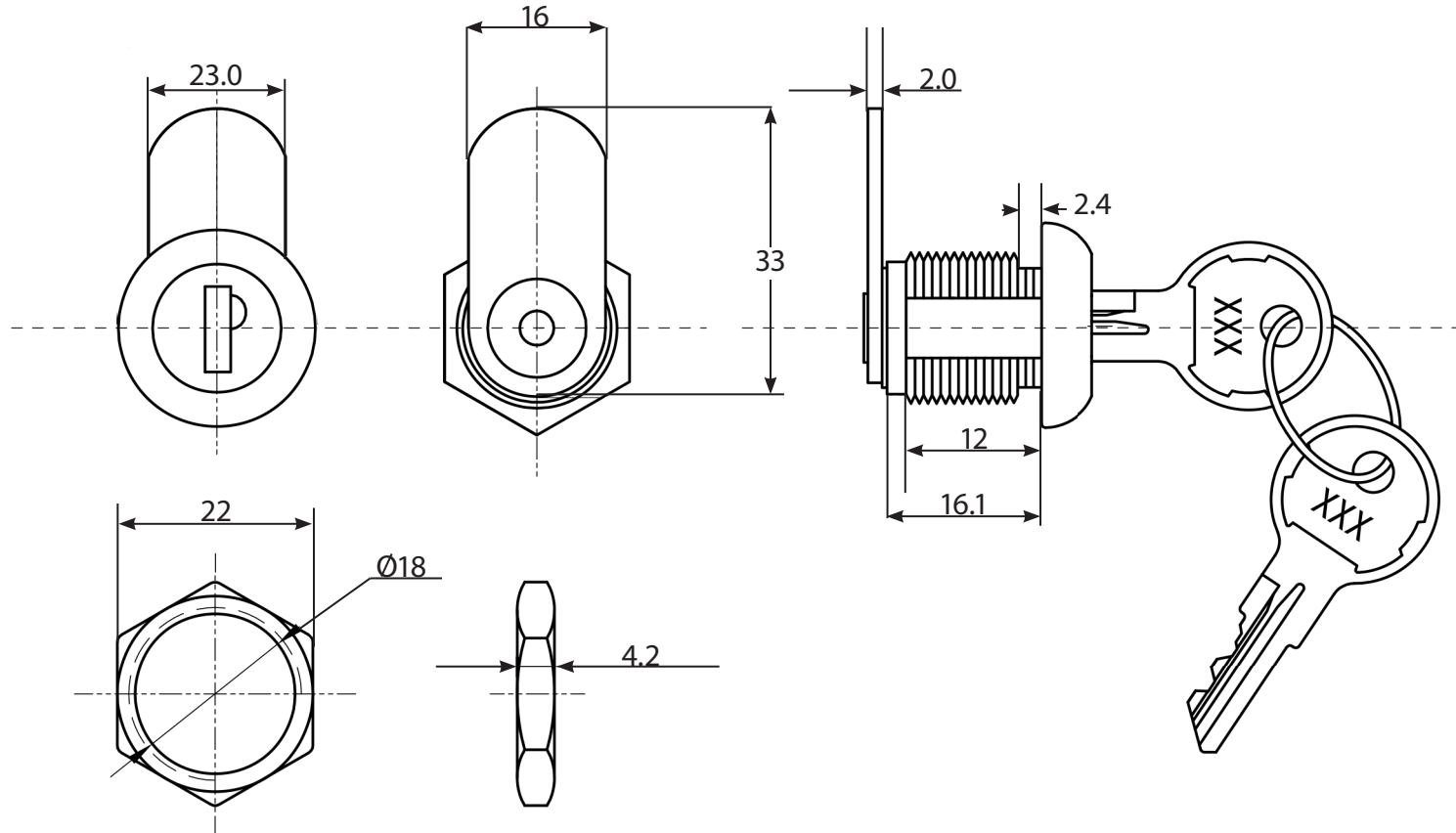

**JIMEXS**  
**HARDWARE**

1 866 447-5656 / INFO@JIMEXS.COM

WWW.JIMEXS-HARDWARE.COM

235-205

Key cylinder with keys #CH505

Cylindre avec clés #CH505

Pour/for 226-101

2022-01-06

PROJECTIONS

