

TECHNICAL DRAWING / DESSIN TECHNIQUE

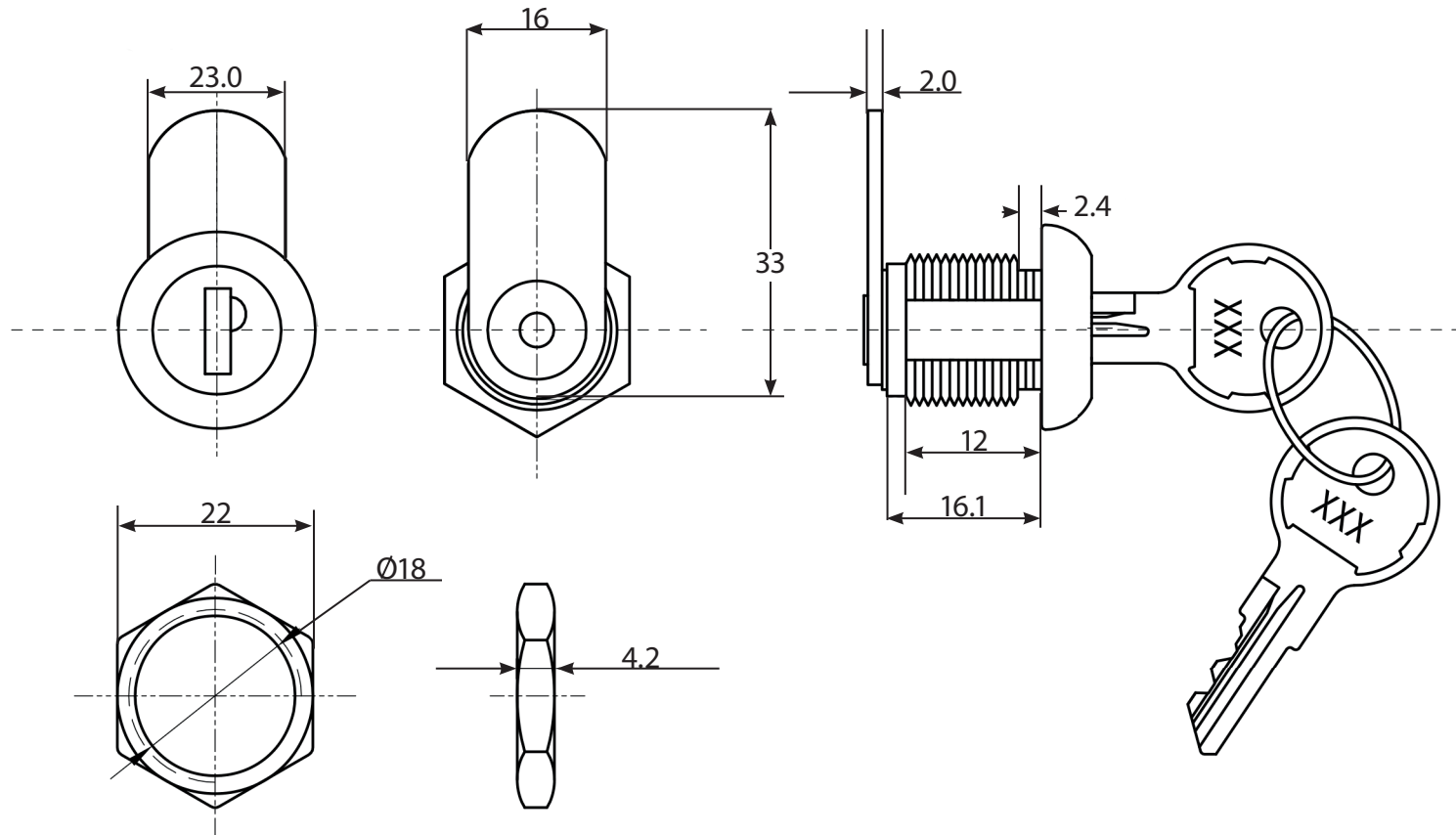

JIMEXS
HARDWARE

1 866 447-5656 / INFO@JIMEXS.COM

WWW.JIMEXS-HARDWARE.COM

235-105

Key cylinder with keys #CH505

Cylindre avec clés #CH505

Pour/for 225-101 + # 225-201

2022-01-05

PROJECTIONS

