

TECHNICAL DRAWING / DESSIN TECHNIQUE

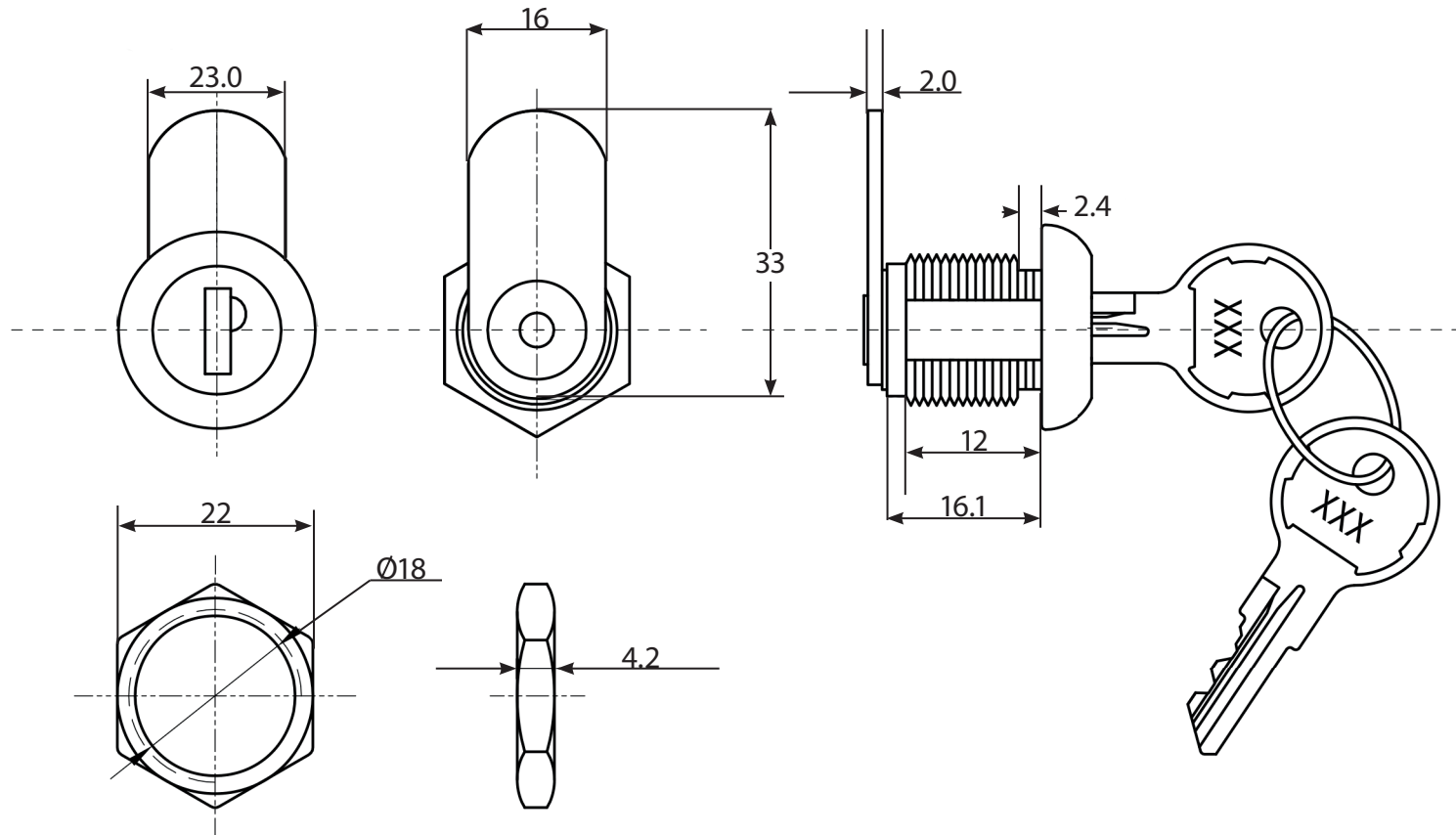

JIMEXS
HARDWARE

1 866 447-5656 / INFO@JIMEXS.COM

WWW.JIMEXS-HARDWARE.COM

235-104

Key cylinder with keys #CH504

Cylindre avec clés #CH504

Pour/for 225-101 + # 225-201

2022-01-06

PROJECTIONS

