

TECHNICAL DRAWING / DESSIN TECHNIQUE

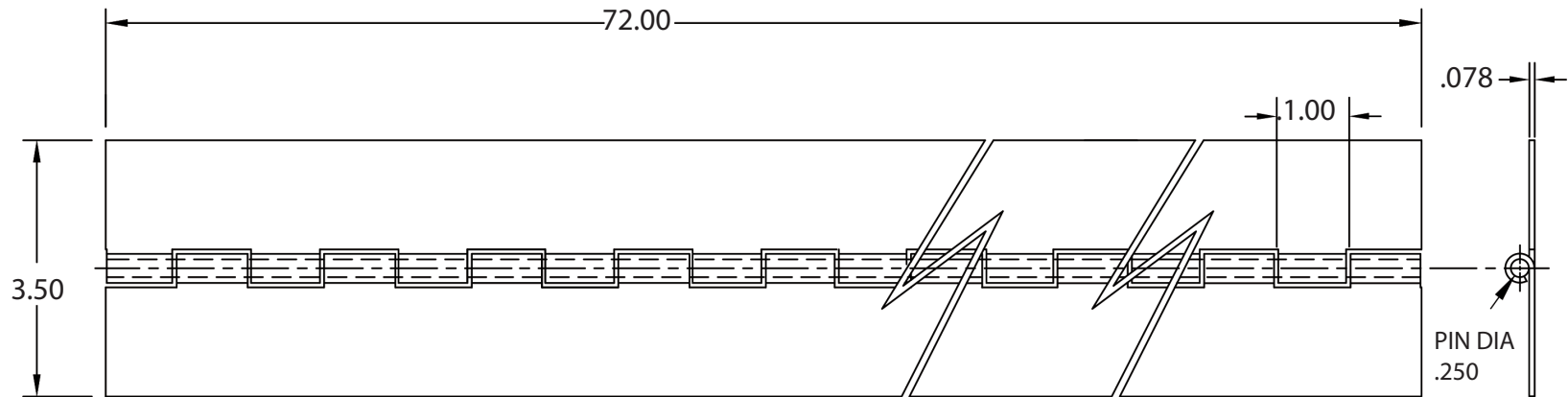

JIMEXS
HARDWARE

1 866 447-5656 / INFO@JIMEXS.COM

WWW.JIMEXS-HARDWARE.COM

210-313

Piano hinge
Penture piano

16-05-2019

PROJECTIONS

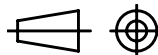

DIMENSIONS

72" x 3-1/2" Open / Ouvert

0,078" Thickness / Épaisseur

0,250" pin diam. / Diam.de tige

1" Knuckle / Articulation

MATERIAL/MATÉRIEL Plain steel and brass pin / Acier brut et tige (laiton)