

TECHNICAL DRAWING / DESSIN TECHNIQUE

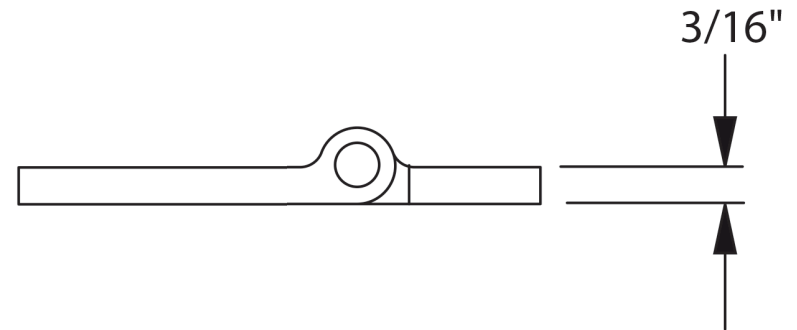
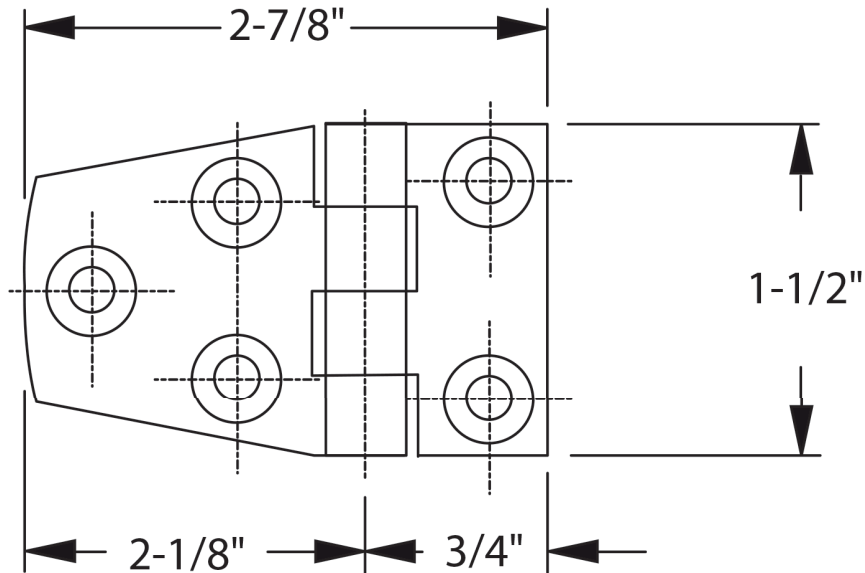

JIMEXS
HARDWARE

1 866 447-5656 / INFO@JIMEXS.COM

WWW.JIMEXS-HARDWARE.COM

202-413

Hinge
Penture

2022-01-06

PROJECTIONS

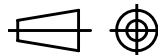

DIMENSIONS

2-7/8" x 1-1/2"

MATERIAL / MATÉRIEL

Cast Stamped stainless steel (316) /

Acier inoxydable coulée (316)