

TECHNICAL DRAWING / DESSIN TECHNIQUE

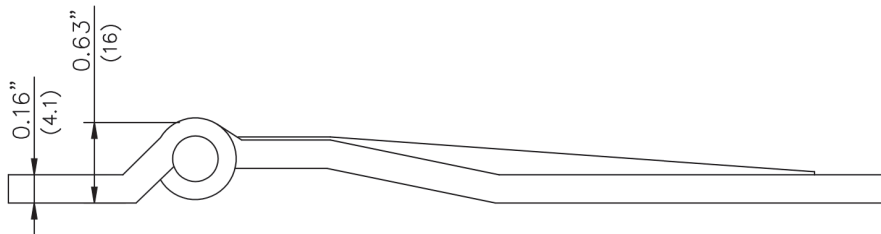
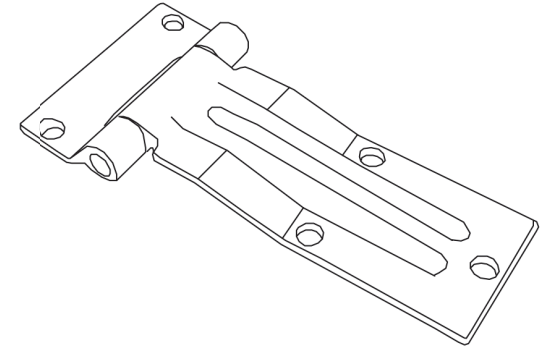
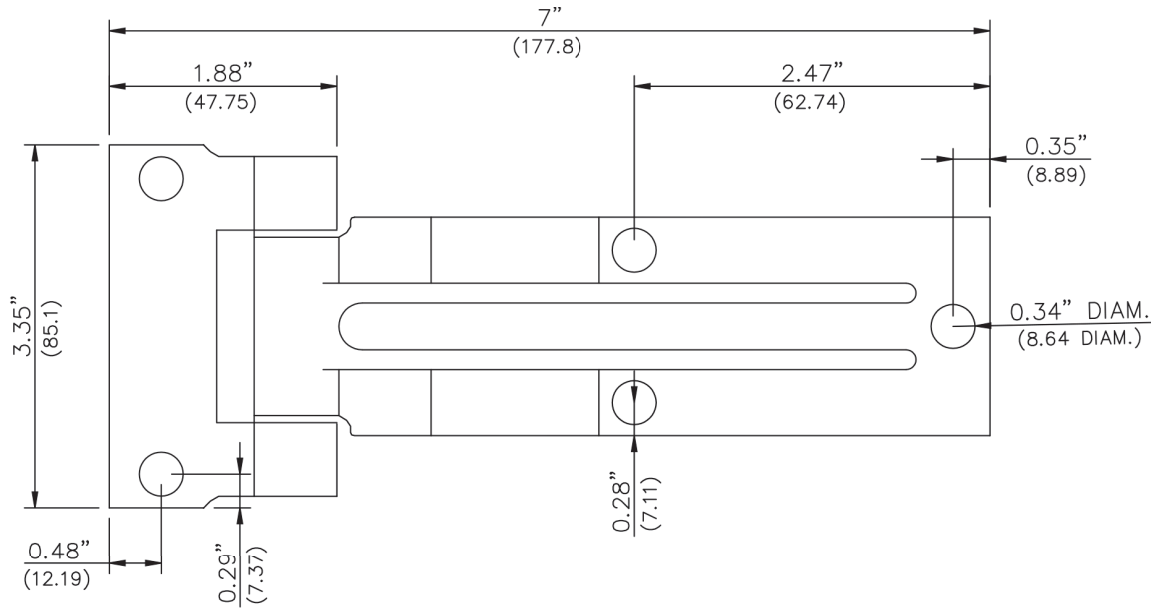

JIMEXS
HARDWARE

1 866 447-5656 / INFO@JIMEXS.COM

WWW.JIMEXS-HARDWARE.COM

202-301

Hinge
 Penture

26-04-2019

PROJECTIONS



DIMENSIONS

5.50"

MATERIAL / MATÉRIEL

Polished stainless steel (304) /

Acier inoxydable poli (304)