

DESSIN TECHNIQUE / TECHNICAL DRAWING

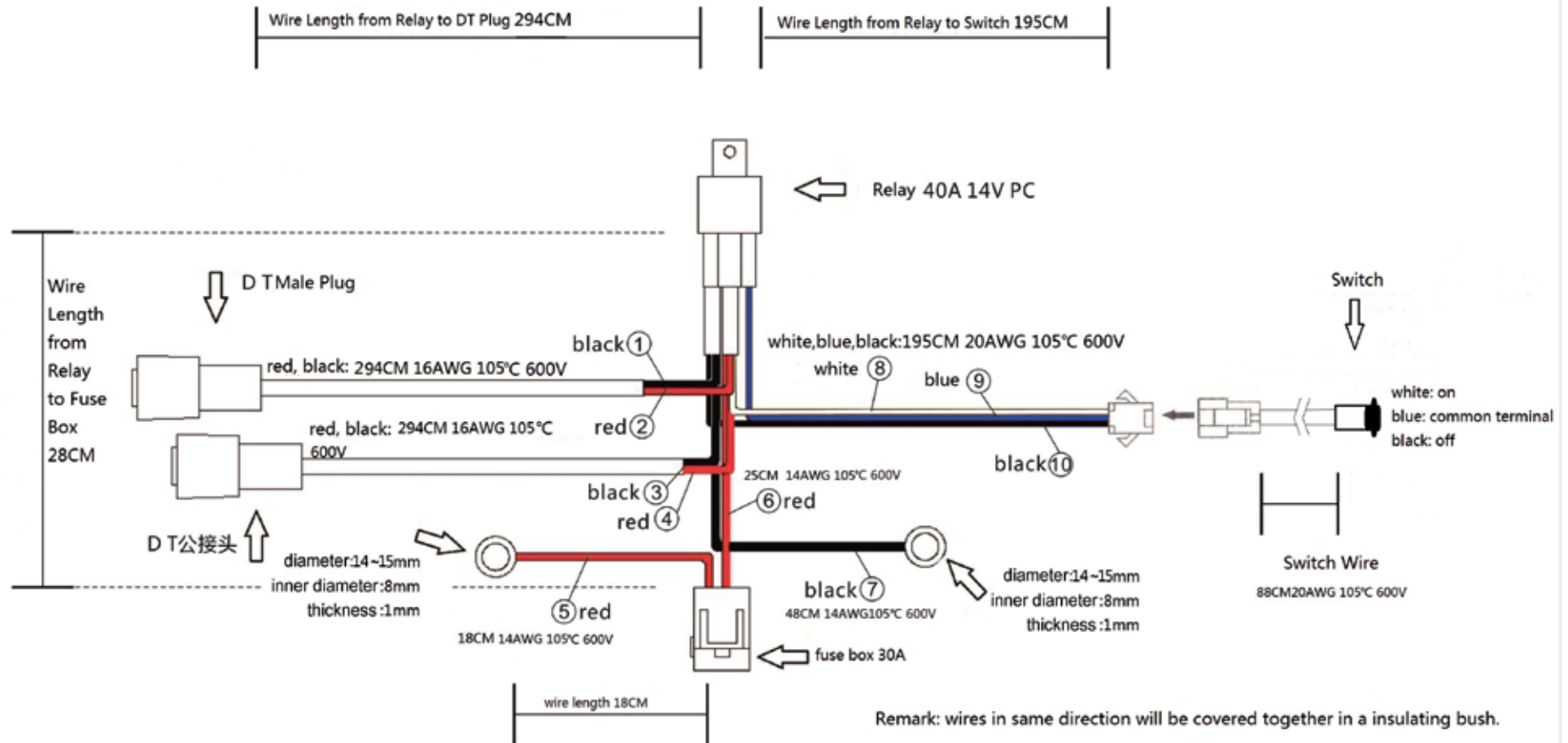

J-LITE
OFF-ROAD
 1 866 447-5656
 INFO@JLITE-OFFROAD.COM
 WWW.JLITEOFFROAD.COM

709-953

Off-Road Wiring Harness 150W or less
 Harnais de câblage Off-Road 150W et moins

2022-02-22

PROJECTIONS



SPECS

1 commutateur - 2 terminaisons - 2 connexion "DT" /
 1 switch - 2 ends - 2 "DT" plug