

TECHNICAL DRAWING / DESSIN TECHNIQUE

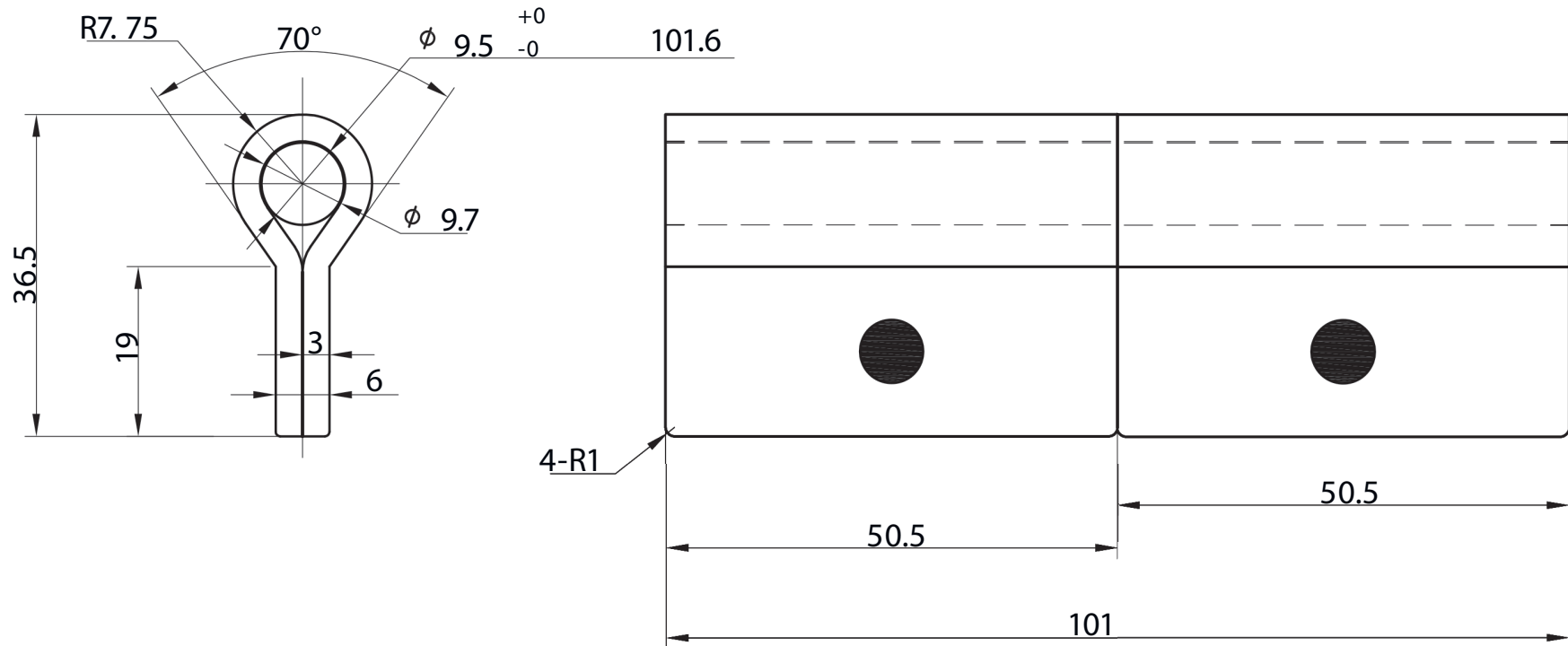

JIMEXS
HARDWARE

1 866 447-5656 / INFO@JIMEXS.COM

WWW.JIMEXS-HARDWARE.COM

203-201

Hinge
Penture

2022-01-06

PROJECTIONS

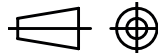

DIMENSIONS 0,375" x 4,00"
MATERIAL / MATÉRIEL Plain steel / Acier nu