

TECHNICAL DRAWING / DESSIN TECHNIQUE

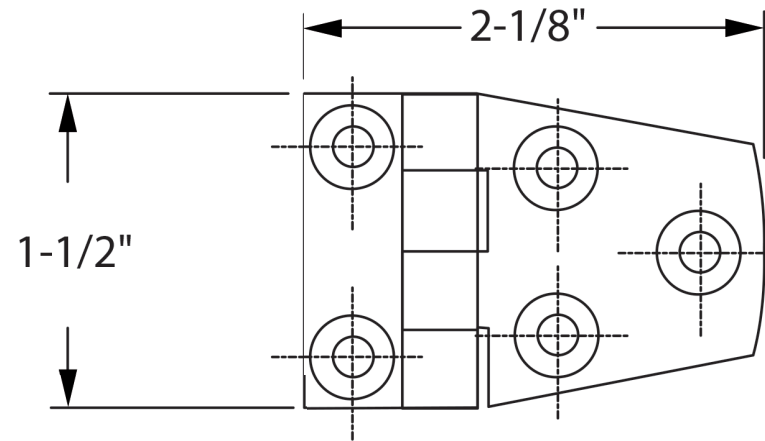
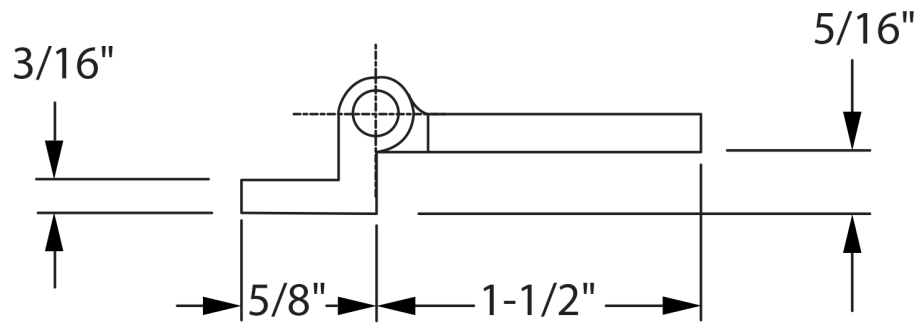

JIMEXS
HARDWARE

1 866 447-5656 / INFO@JIMEXS.COM

WWW.JIMEXS-HARDWARE.COM

202-421

Hinge
Penture

2022-01-06

PROJECTIONS

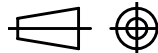

DIMENSIONS

$2-1/8'' \times 1-1/2''$

MATERIAL / MATÉRIEL Cast Stamped stainless steel (316) /

Acier inoxydable coulée (316)